

# Efficient large-scale production and concentration of HIV-1-based lentiviral vectors for use in vivo

JASON E. COLEMAN,<sup>1\*</sup> MATTHEW J. HUENTELMAN,<sup>2\*</sup> SERGEY KASPAROV,<sup>4</sup>  
BEVERLY L. METCALFE,<sup>2</sup> JULIAN F. R. PATON,<sup>4</sup> MICHAEL J. KATOVICH,<sup>3</sup>  
SUSAN L. SEMPLE-ROWLAND,<sup>1</sup> AND MOHAN K. RAIZADA<sup>2</sup>

Departments of <sup>1</sup>Neuroscience and <sup>2</sup>Physiology and Functional Genomics, University of Florida McKnight Brain Institute and College of Medicine, and <sup>3</sup>Department of Pharmacodynamics, University of Florida College of Pharmacy, Gainesville, Florida 32610; and <sup>4</sup>Department of Physiology, University of Bristol School of Medical Sciences, Bristol BS8 1TD, United Kingdom

Submitted 8 October 2002; accepted in final form 5 December 2002

**Coleman, Jason E., Matthew J. Huentelman, Sergey Kasparov, Beverly L. Metcalfe, Julian F. R. Paton, Michael J. Katovich, Susan L. Semple-Rowland, and Mohan K. Raizada.** Efficient large-scale production and concentration of HIV-1-based lentiviral vectors for use in vivo. *Physiol Genomics* 12: 221–228, 2003. First published December 10, 2002; 10.1152/physiolgenomics.00135.2002.—The aim of this study was to develop an efficient method for packaging and concentrating lentiviral vectors that consistently yields high-titer virus on a scale suitable for in vivo applications. Transient cotransfection of 293T packaging cells with DNA plasmids encoding lentiviral vector components was optimized using SuperFect, an activated dendrimer-based transfection reagent. The use of SuperFect allowed reproducible and efficient production of high-titer lentiviral vector at concentrations greater than  $1 \times 10^7$  transducing units per ml (TU/ml) and required less than one-third of the total amount of DNA used in traditional calcium phosphate transfection methods. Viral titers were further increased using a novel concentration protocol that yielded an average final titer of  $1.4 \times 10^{10}$  TU/ml. Lentiviruses produced using these methods exhibited efficient transduction of central nervous system and peripheral tissues in vivo. The method is reproducible and can be scaled up to facilitate the use of these vectors in animal studies.

cardiomyocytes; in vivo gene delivery; neurons; retina; transfection

---

LENTIVIRAL VECTORS DERIVED from the human immunodeficiency virus type 1 (HIV-1) are emerging as the vectors of choice for long-term, stable in vitro and in vivo gene transfer. These vectors are attractive because they can carry large transgenes (up to 18 kb in size)

---

\*J. E. Coleman and M. J. Huentelman contributed equally to this work.

Article published online before print. See web site for date of publication (<http://physiolgenomics.physiology.org>).

Addresses for reprint requests and other correspondence: S. L. Semple-Rowland, UF McKnight Brain Institute, Dept. of Neuroscience, 100 Newell Dr., Bldg 59, Rm L1–100, Gainesville, FL 32610-0255 (E-mail: rowland@mbi.ufl.edu); and M. K. Raizada, UF McKnight Brain Institute, Dept. of Physiology and Functional Genomics, Box 100274, Gainesville, FL 32610-0255 (E-mail: mraizada@phys.med.ufl.edu).

(13) and they are capable of stably transducing both dividing and quiescent cells (10, 14, 24).

The increase in interest in these vectors has given rise to a need for efficient and reproducible methods to produce large quantities of high-titer lentiviral vector. Traditionally, lentiviral vectors are produced by cotransfecting human cell lines with plasmid DNA that encodes the viral components required for packaging. Transient transfection of these cell lines is often accomplished using the conventional calcium phosphate coprecipitation technique (15). Disadvantages of this method include 1) the large amount of plasmid DNA that is required for transfection; 2) the difficulties associated with scaling up the precipitation reaction; and 3) the high degree of variability observed in transfection efficiency and viral production. Recently, several groups have developed packaging cell lines that facilitate the production of lentiviral vectors by reducing the need for multiplasmid transfections (6, 12, 16, 20). Although the use of packaging cell lines has streamlined the packaging procedure, the resulting viral titers have not been significantly higher than those obtained using transient cotransfection methods. In addition, the advantages of these new cell lines are often offset by the need to develop new lines for each generation of improved lentiviral vector.

To achieve large-scale production of high-titer lentiviral vector, it is critical that transfection of the virus-producing cell cultures be both efficient and reproducible; however, little effort has been put forth to optimize this step in vector production. The goal of this study was to develop efficient and reproducible transfection and concentration methods for the production of high-titer lentiviral vector stocks. By combining a transfection method that utilizes the activated dendrimer-based transfection reagent, SuperFect (Qiagen), with a novel vector concentration protocol, we were able to reproducibly generate lentiviral vector stocks with titers greater than  $1 \times 10^{10}$  transducing units per ml (TU/ml) using less than one-third of the total amount of plasmid DNA that is commonly required for production of this vector. The viruses pro-

duced using these methods exhibit high transduction efficiencies in vivo.

## MATERIALS AND METHODS

### Lentiviral Vector Constructs

The transducing vector used in our experiments was derived from a previously described self-inactivating vector (5, 10). The pTY vector was modified by inserting a central polypurine tract (cPPT)-DNA FLAP element upstream of the multiple cloning site, an element that has been shown to significantly improve the transduction efficiency of recombinant lentiviral vectors in vitro and in vivo (8, 23). A 186-bp fragment containing the cPPT-DNA FLAP sequence was amplified from the pNHP vector using the polymerase chain reaction (PCR) and the same core primers that have been previously described (22). *EagI* and *NotI* restriction sites were added to the sense and antisense primers, respectively. The resulting fragment was cloned into the *NotI* site of the pTY vector in the sense orientation creating the pTYF vector. The integrity of this modification was verified by DNA sequencing. The pTYF vector used in these experiments carries a placental alkaline phosphatase (PLAP) reporter gene (3) driven by the human elongation factor-1 $\alpha$  (EF1 $\alpha$ ) promoter (21). For some experiments, PLAP was replaced with an enhanced green fluorescent protein (eGFP) reporter gene. Transfection-grade DNA was prepared using endotoxin-free DNA mega- or maxiprep kits (Qiagen).

### Lentiviral Vector Production, Concentration, and Titers

Vesicular stomatitis virus G (VSV-G) glycoprotein-pseudotyped lentiviruses carrying an EF1 $\alpha$ -PLAP or EF1 $\alpha$ -eGFP transgene were prepared using the lentiviral vector system illustrated in Fig. 1. The 293T cells (Invitrogen, no. R70007) were seeded in 75-cm<sup>2</sup> (T-75) culture flasks at a density of  $1 \times 10^7$  cells/flask and grown in Dulbecco's modified Eagle's medium (DMEM; GIBCO) containing 10% fetal bovine serum and antibiotics (130 U/ml penicillin and 130  $\mu$ g/ml streptomycin; growth medium). The cultures were maintained at 37°C in 5% CO<sub>2</sub> throughout the virus production period. On the following day, when the cultures reached 90–95% confluence, the growth medium was replaced with 5.0 ml of fresh medium. For one large-scale preparation of virus, 20 T-75

flasks of 293T cells were transfected as follows. Transfection mixture for all 20 flasks was prepared by gently mixing 142  $\mu$ g pNHP, 70  $\mu$ g pTYF, and 56  $\mu$ g pHEF.VSVG plasmid DNA and 8.0 ml DMEM in one 50-ml polystyrene tube. After mixing, 560  $\mu$ l of SuperFect was added to the DNA solution. The contents of the tube were gently mixed and incubated at room temperature for 10 min. Next, 430  $\mu$ l of the SuperFect-DNA mixture was added drop-wise to the T-75 flask (transfection start point), and the flask was incubated for 4–5 h. Following the incubation period, the medium containing the transfection mixture was replaced with 7.0 ml of fresh growth medium. The next day, the media containing the first batch of virus was harvested from each flask, and 6.5 ml of fresh growth medium was added to the cells. Upon collection, all virus-containing media was filtered through a 0.45- $\mu$ m low-protein-binding Durapore filter (Millipore) to remove cell debris. To prepare transfection mixture sufficient for one T-75 flask, the amounts of DNA, DMEM, and SuperFect were each divided by 20 to scale the reaction down. We have also found that viral vector can be produced in larger or smaller cell culture flasks or plates by simply scaling cell numbers and the amount of DNA, DMEM, and SuperFect linearly with respect to the cell growth area.

For some experiments, virus-containing media was concentrated using ultrafiltration and centrifugation as outlined in Fig. 3. For ultrafiltration, the virus stock collected from 20 T-75 flasks at 30 h posttransfection (~120 ml) was divided into two 60-ml aliquots and centrifuged through Centri-con-80 ultrafiltration columns (Millipore) for 1 h in 4°C at 2,500 *g*. The retentate was retrieved by centrifuging the inverted column for 1 min in 4°C at 990 *g* and was stored at 4°C until further processing. On the following day, the virus-containing retentate was added to the ~120 ml of virus-containing media collected at 45 h posttransfection. Four 30-ml conical-bottom tubes (polyallomer Konical tubes; Beckman), each containing a 220  $\mu$ l cushion of 60% iodixanol solution (used directly from the Optiprep stock solution obtained from Axis-Shield), were prepared. Iodixanol was used because of its demonstrated safety in human clinical trials (11). Media containing virus (30 ml) was gently pipetted into each tube, taking care not to disturb the iodixanol, and the samples were centrifuged at 50,000 *g* for 2.5 h at 4°C using a Beckman SW-28 swinging bucket rotor. The media just above

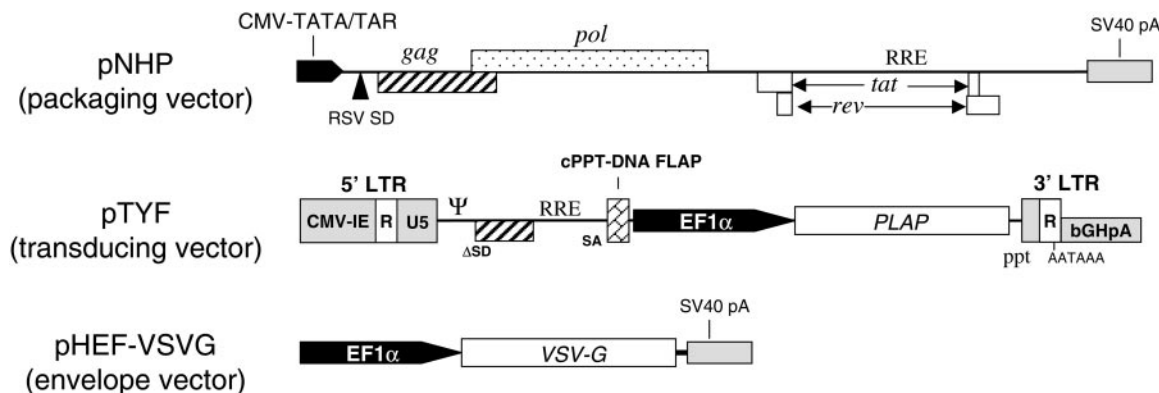

Fig. 1. The HIV-1-based self-inactivating lentiviral vector system. The helper construct, pNHP, contains deletions in the regions encoding the accessory proteins *vif*, *vpr*, *vpu*, and *nef* and has been previously described (21). The self-inactivating transducing construct, pTYF, has a central polypurine tract (cPPT)-DNA FLAP element located just upstream of the multiple cloning site and carries an EF1 $\alpha$ -PLAP transgene. The packaging construct, pHEF.VSVG, encodes the vesicular stomatitis virus G (VSV-G) glycoprotein for pseudo-typing (2). The pTYF.EF1 $\alpha$ .PLAP construct was used to produce vector for the in vitro and in vivo experiments unless stated otherwise. PLAP, placental alkaline phosphatase.

the media/iodixanol interface was carefully removed from each tube and discarded, leaving  $\sim 750 \mu\text{l}$  of the solution in each tube ( $220 \mu\text{l}$  of iodixanol plus  $\sim 500 \mu\text{l}$  of media). The residual media containing virus and the iodixanol were mixed gently by shaking at 200 rpm for 2–3 h at  $4^\circ\text{C}$ . The resulting mixtures were pooled into one 3-ml conical-bottom tube (polyallomer Konical tubes; Beckman) and centrifuged at  $6,100 g$  for 22–24 h at  $4^\circ\text{C}$  using a Beckman SW-50.1 swinging bucket rotor. The resulting supernatant was removed and discarded, and the remaining pellet was resuspended in  $50 \mu\text{l}$  of PBS or artificial cerebrospinal fluid by incubating the virus at  $4^\circ\text{C}$  for 10–14 h. The final viral vector was gently mixed by pipetting, then aliquoted and stored at  $-80^\circ\text{C}$  until use.

Infectious titers of the TYF.EF1 $\alpha$ .PLAP virus were determined by incubating  $1.75 \times 10^5$  TE671 cells seeded in 12-well plates with limiting dilutions of the viral stock (1/10, 1/100, and 1/1,000) in the presence of  $8 \mu\text{g/ml}$  Polybrene. After a 4–5 h incubation period, fresh medium was added directly to the cells and, after 48 h, cultures were fixed, rinsed in PBS, heated in PBS at  $65^\circ\text{C}$  for 30 min and stained for PLAP activity using previously reported methods (7). The number of transducing units (TU; defined as an infectious particle) was determined by estimating the number of PLAP-positive cells per well, and final infectious titers were expressed as “TU/ml.”

#### Delivery of EF1 $\alpha$ -PLAP Vector to Chicken Neural Tube

The neural tube injections and preparation of retinal flat mounts were carried out using previously described methods (4). The brains of injected embryos were fixed overnight in 4% paraformaldehyde at  $4^\circ\text{C}$ . The next day, the tissues were rinsed thoroughly in PBS, and  $100\text{-}\mu\text{m}$  thick sections were cut using a Vibratome. Floating brain sections and retinal flat mounts were subsequently processed for routine PLAP histochemistry as described above. All tissues were collected on embryonic day 7 (E7), 5 days after injections. Digital images of retinal flat mounts were captured with a Nikon Coolpix 995 camera fitted to a Zeiss Stemi V6 microscope. The percent area of retina transduced by the vector was determined as follows: TIFF images at a resolution of  $1,024 \times 768$  pixels were reduced by 35%, converted to grayscale using Adobe Photoshop, and imported into the Scion Image program (available at <http://www.scioncorp.com>). The density slice setting was used to select all of the pixels within the area of the flat mount that represented PLAP-positive areas, and these were expressed as a percent of the total retinal area. Three to seven retinas were analyzed for each dose of vector.

#### Delivery of EF1 $\alpha$ -eGFP Vector to Brain Nuclei

Male Wistar rats were anesthetized with a mixture of ketamine (60 mg/kg) and medetomidine ( $250 \mu\text{g/kg}$ ) and placed in a stereotaxic frame. Vector delivered to the brain was suspended in artificial cerebrospinal fluid. For the paraventricular nucleus (PVN) injections, 275-g rats were used, and the head of the animal was flexed 5 mm below the interaural line. The microinjection pipette was angled  $10$  degrees relative to the midline to avoid the midsagittal sinus. A slow injection of  $500 \text{ nl}$  ( $5 \times 10^5$  TU) of virus was performed at the following coordinates: 1.8 mm lateral, 1.8 mm caudal to the bregma, and 7.5 mm below the surface. The caudal nucleus of the solitary tract (NTS) was also injected bilaterally with three injections per side for a total of  $300 \text{ nl}$  ( $3 \times 10^5$  TU). Injections were made at the level of calamus scriptorius and up to  $500 \mu\text{m}$  caudal to it,  $350\text{--}700 \mu\text{m}$  from midline, and

$500\text{--}600 \mu\text{m}$  below the dorsal surface of the medulla. The head of the animal was flexed 10 mm below the interaural line. The animals were killed either 7 days (PVN,  $n = 2$ ) or 30 days (NTS,  $n = 2$ ) following the injections and fixed by intracardial perfusion with 4% paraformaldehyde in PBS. Brains were removed and cryoprotected in 30% sucrose, then  $60\text{-}\mu\text{m}$ -thick brain sections were cut on a cryostat, and confocal microscopy (Leica SP) was used to visualize GFP fluorescence.

#### Systemic Delivery of EF1 $\alpha$ -PLAP Vector to Neonatal Rat

Twelve, 5-day-old Sprague-Dawley rats (Charles River, Wilmington, MA) were divided into two groups. Six rats in the control group received injections of artificial cerebrospinal fluid (viral suspension buffer), while the remaining six animals received  $2.5 \times 10^8$  TU of TYF.EF1 $\alpha$ .PLAP virus. A single bolus of vehicle or virus was administered in a total volume of  $25 \mu\text{l}$  into the chamber of the left ventricle of the heart (9). Animals were killed at 30 ( $n = 4$  per group) and 120 ( $n = 2$  per group) days postinjection. Tissues were processed for routine PLAP histochemistry as described above. Digital images were obtained using the methods described above.

## RESULTS

### Lentivirus Production and Concentration

The goals of our first series of experiments were to determine the optimum ratio of total plasmid DNA to SuperFect reagent that produced the highest titer virus and the optimum time for viral harvest. This ratio was determined to be 1:2 (ratios of 1:1, 1:1.5, 1:2, 1:5, and 1:10 were tested; data not shown). The titers of virus-containing media harvested directly from transfected 293T cultures were determined 30, 45, 60, and 70 h posttransfection to identify the timeframe during which virus production by these cultures is at maximum levels (Fig. 2). The average titer values were  $8.0 \times 10^6$ ,  $6.8 \times 10^6$ ,  $2.6 \times 10^6$ , and  $0.8 \times 10^6$  TU/ml at 30, 45, 60, and 70 h posttransfection, respectively. Therefore, we collected culture media 30 and 45 h posttransfection for subsequent experiments. It should also be noted that 293T cells passaged between 2 and 60 times were used for transfections and that passage

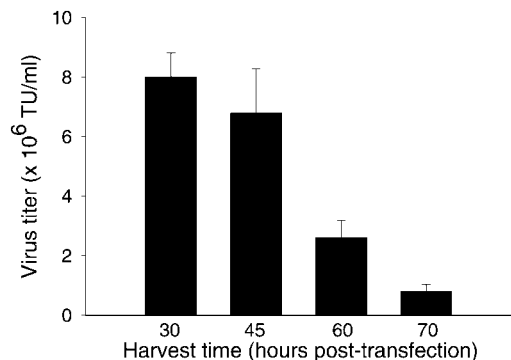
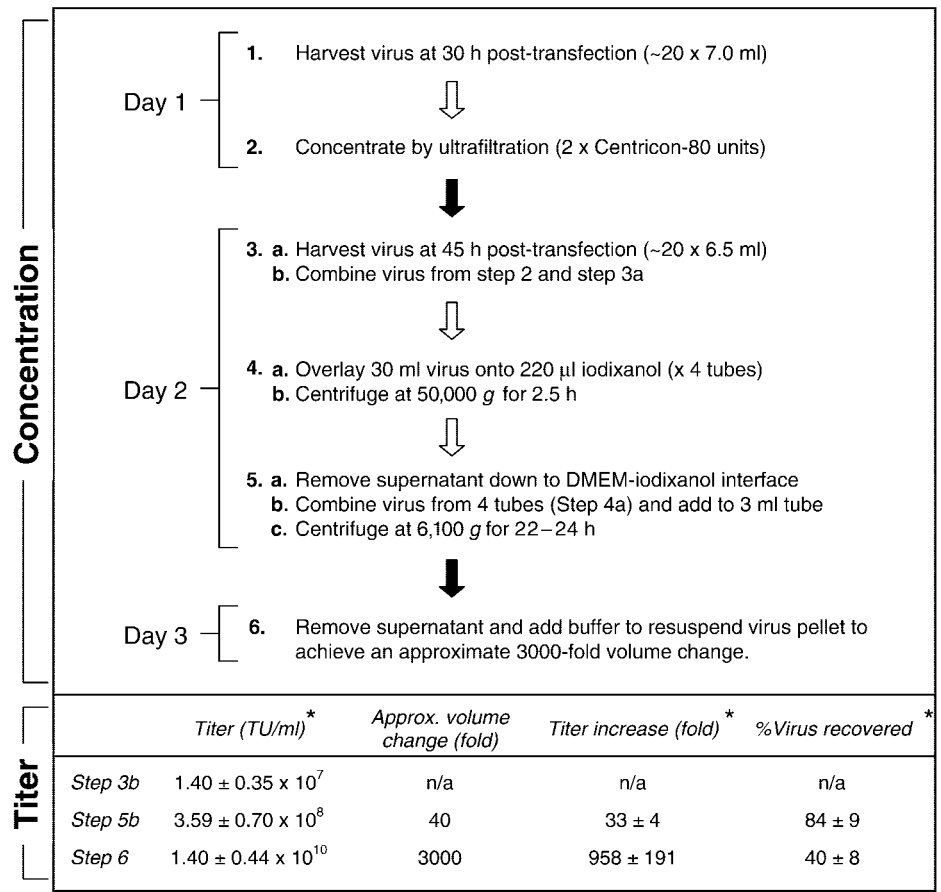

Fig. 2. Production of lentivirus by transfected 293T cells as a function of time. VSV-G-pseudo-typed lentiviruses carrying an EF1 $\alpha$ -PLAP transgene were prepared using the lentiviral vector system illustrated in Fig. 1. Each bar represents the mean titer  $\pm$  SE of unconcentrated virus-containing medium collected at each time point ( $n = 3$ ).



Fig. 3. Outline and results of the vector production protocol. *Top*: a simplified flow diagram of the concentration procedure that is described in detail under MATERIALS AND METHODS. *Bottom*: summary of the viral titer results obtained following each step of the concentration procedure.



\*Mean ± SEM derived from 13 separate large-scale virus preparations

number did not significantly affect transfection efficiency or final vector titers.

The goal of our second series of experiments was to develop a concentration protocol that would minimize virus loss and yield the highest titer virus in the smallest possible volume. The concentration procedure and results are summarized in Fig. 3. The average starting titer of the virus-containing media (Fig. 3, steps 1–3) was  $1.40 \pm 0.35 \times 10^7$  TU/ml. The next step in the concentration procedure (Fig. 3, step 4) yielded an average titer of  $3.59 \pm 0.70 \times 10^8$  TU/ml in a volume of ~3.0 ml, resulting in a 33-fold increase in titer and an average recovery of 84%. Further concentration of the virus stock by low-speed centrifugation (Fig. 3, steps 5c and 6) yielded  $1.40 \pm 0.44 \times 10^{10}$  TU/ml, a 958-fold increase over the average starting titer. The average overall percent recovery of the virus was 40%.

#### *In Vivo Performance of the Lentiviral Vector*

**Embryonic chicken retina and brain.** Administration of ~0.5 µl of TYF.EF1α.PLAP virus ( $1 \times 10^{10}$  TU/ml) into the chicken neural tube resulted in efficient transduction of large numbers of neural progenitor cells (Fig. 4). Cross sections of stained retinas revealed numerous PLAP-positive cell columns (data not shown). Columns of PLAP-positive cells were also ob-

served throughout the developing brain (Fig. 4E). We also examined the relationship between viral dose and the percent of the retina transduced by the virus and determined that the transduction efficiency of the virus in developing retina was dose dependent (Fig. 4, A–C). The percent of total retinal area exhibiting PLAP expression was estimated to be 5%, 63%, and 85% in embryos receiving injections of  $10^8$ ,  $10^9$ , and  $10^{10}$  TU/ml vector, respectively (Fig. 4D).

**Transduction of PVN and NTS in the adult rat brain.** Lentiviral vector carrying an EF1α-eGFP transgene was delivered into the PVN and the NTS of the adult rat brain. Examination of transverse sections cut from the brains of animals either 7 days (PVN) or 30 days (NTS) after injection revealed that the vector transduced a high proportion of cells in both nuclei as evidenced by the presence GFP-positive cells (Fig. 5). Many GFP-positive cells exhibited a neuronal phenotype (Fig. 5C), and in many cases fluorescent axons could be seen hundreds of microns away from the area of concentration of fluorescent cell bodies.

**Systemic delivery of lentiviral vector in neonatal rat pups.** PLAP-encoding virus ( $2.5 \times 10^8$  TU in 25 µl) was injected into the left ventricular space of the heart of 5-day-old rats. PLAP-positive cells were found in the heart, liver, lung, kidney, adrenal gland, brain, and

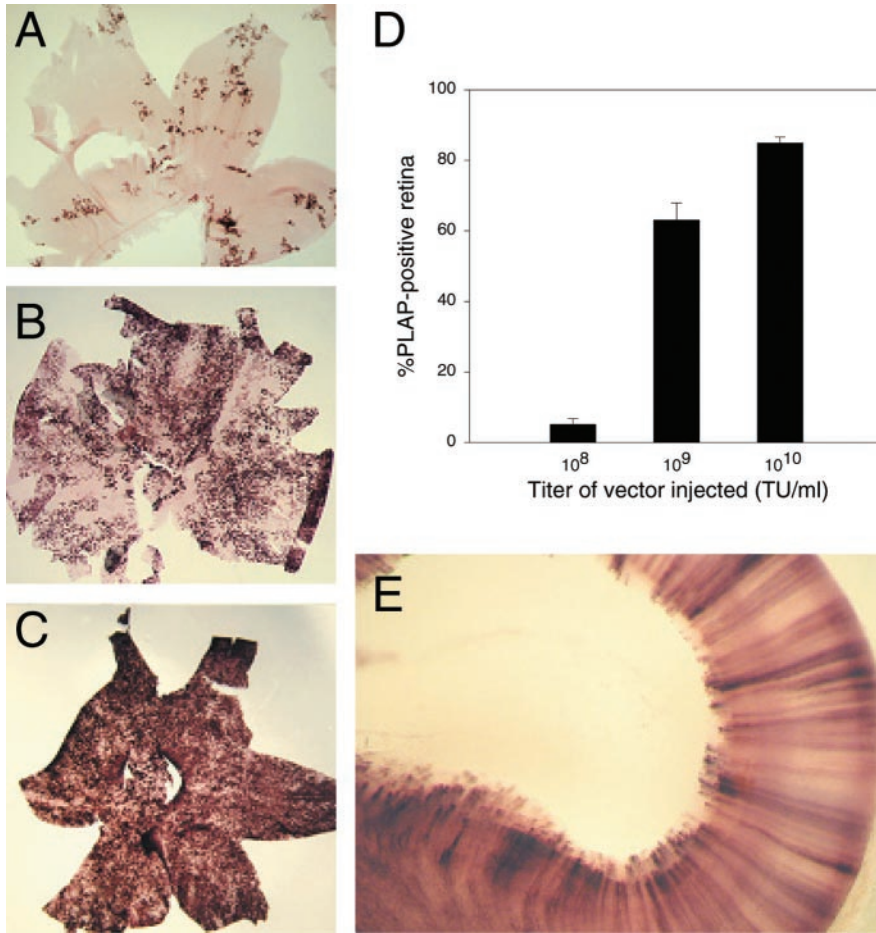

Fig. 4. Lentiviral vector-mediated transduction of PLAP in chicken neural progenitor cells. A–C: PLAP expression in representative flat mounts of *E7* chicken retinas from embryos receiving injections of 10<sup>8</sup> (A), 10<sup>9</sup> (B), or 10<sup>10</sup> TU/ml (C) virus. D: histogram showing the quantification of the percent area of PLAP-positive retina following injections of different doses of vector. Bars are means ± SE for each group (*n* = 3–7). E: cross section showing PLAP-positive cells in the lateral anterior cortex of an *E7* embryo that had received a neural tube injection of 10<sup>10</sup> TU/ml virus.

testes 30 days after viral administration (Fig. 6). The liver and heart exhibited the highest level of transduction. Analyses of whole organs indicated that the TYF.EF1α.PLAP virus transduced ~30% of the heart tissue (Fig. 6E) and 40% of the liver tissue (Fig. 6G). PLAP-positive cells in the heart were distributed throughout both the atria and ventricles; morphologi-

cal examination revealed that 90–95% of the stained cells in the ventricles were cardiomyocytes (Fig. 6E, inset). Similar staining patterns and transduction efficiencies were observed at 120 days postinjection. Limited, but significant expression of PLAP was observed in the testes of 120-day-old rats. Several spermatogonium-like cells situated near the perimeter of the tes-

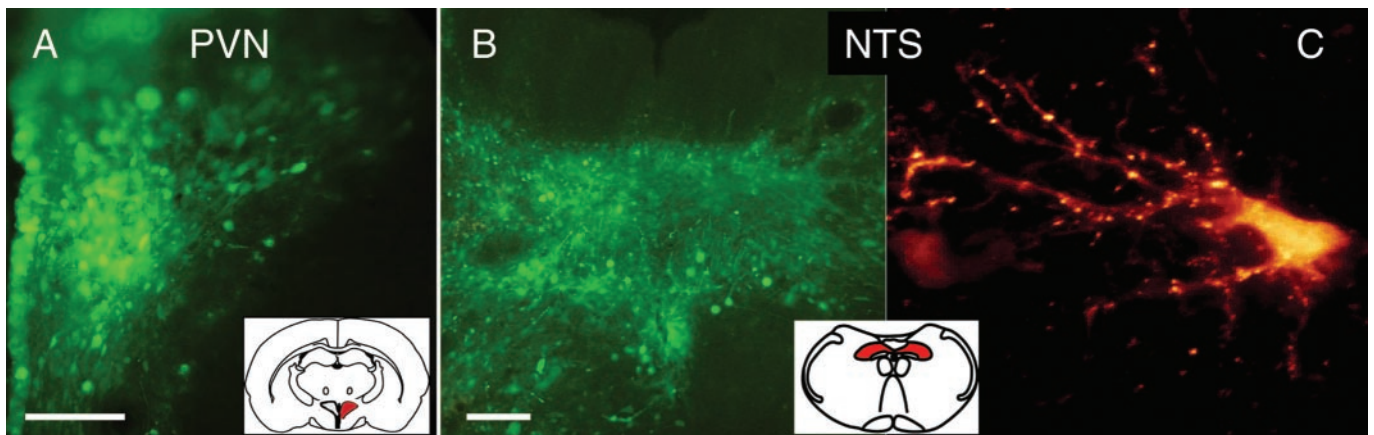

Fig. 5. Lentiviral vector-mediated transduction of green fluorescent protein (GFP) in the paraventricular nucleus (PVN) and the nucleus of the solitary tract (NTS): confocal microscope images of GFP-expressing cells in the PVN (A) (bar = 150 μm) and the NTS (B) (bar = 200 μm) following injection of vector into these sites. Insets are provided for reference. C: a pseudo-colored image of a GFP-expressing cell from the NTS exhibiting neuronal morphology.



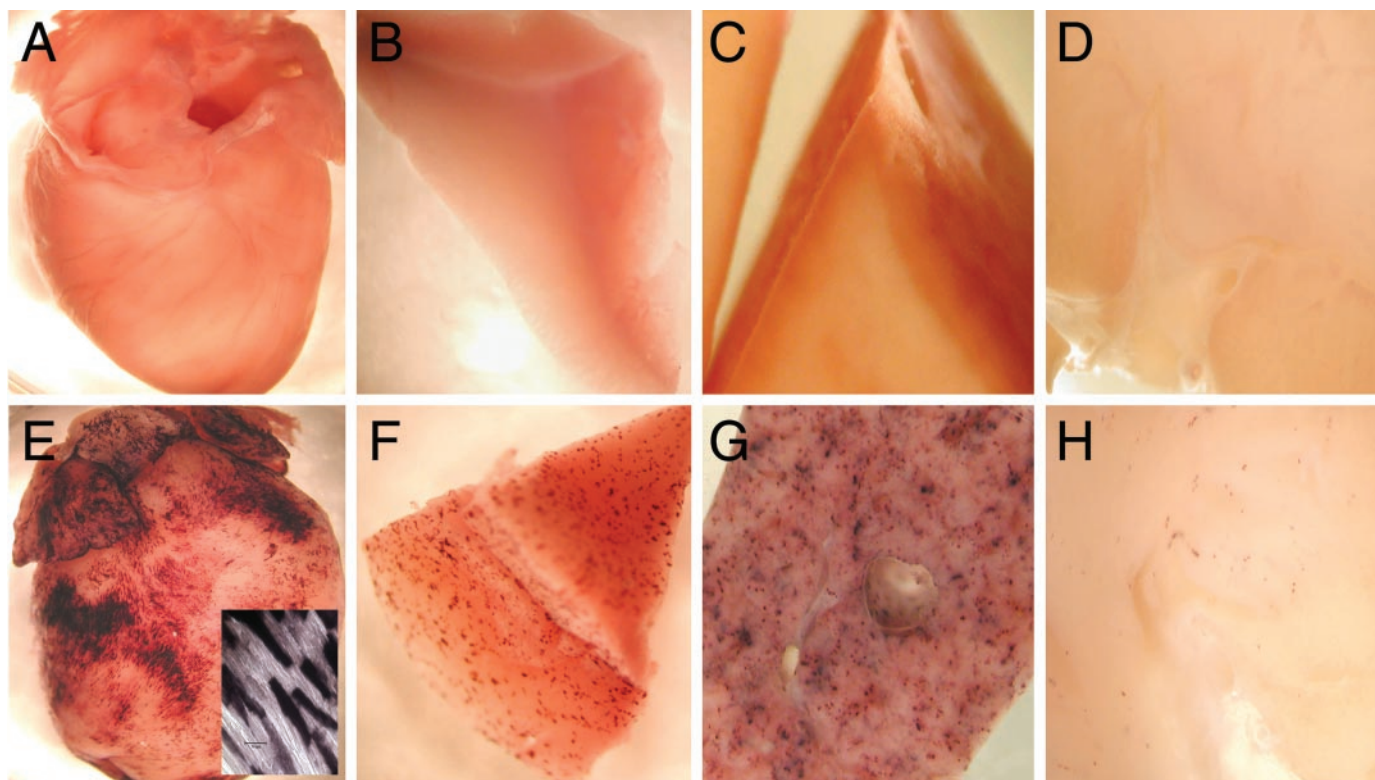

Fig. 6. Lentiviral vector-mediated transduction of PLAP in peripheral tissues. Lentiviral vector encoding PLAP was injected intracardially in 5-day-old rats as described in the METHODS AND MATERIALS. Tissues were removed and stained for PLAP activity in toto 30 days after the administration of vehicle (A–D) or  $2.5 \times 10^8$  TU of PLAP-encoding vector (E–H): heart (A and E), lung (B and F), liver (C and G), and kidney (D and H). *Inset of E* is a thin section of the left ventricle showing several positively stained cells with cardiomyocyte morphology (bar = 50  $\mu$ m).

ticular tubules exhibited PLAP expression, indicating that administration of vector into the systemic circulation of neonates can result in transduction of germ cells (Fig. 7).

#### DISCUSSION

By optimizing both the DNA transfection and viral concentration steps for production of lentiviral vector,

we have overcome many of the problems that we had previously encountered in our efforts to produce large volumes of high-titer lentiviral vector in a consistent manner. We found that SuperFect-mediated transfection of viral packaging cells consistently yielded large-scale vector stocks ( $\sim 120$  ml) with starting titers averaging  $>1.0 \times 10^7$  TU/ml, titers that were comparable to vector stocks prepared using other transfection re-

Fig. 7. Germ cell transduction following peripheral administration of lentiviral vector encoding PLAP. A: cross section of the testes from an animal injected with saline (vehicle control). No background PLAP activity is seen (bar = 100  $\mu$ m). B: cross section of the testes from an injected animal showing PLAP-positive germ cells 120 days after the administration of  $2.5 \times 10^8$  TU of PLAP-encoding vector. Note the positively stained mature sperm located in the center of the tubule (arrow; bar = 50  $\mu$ m).

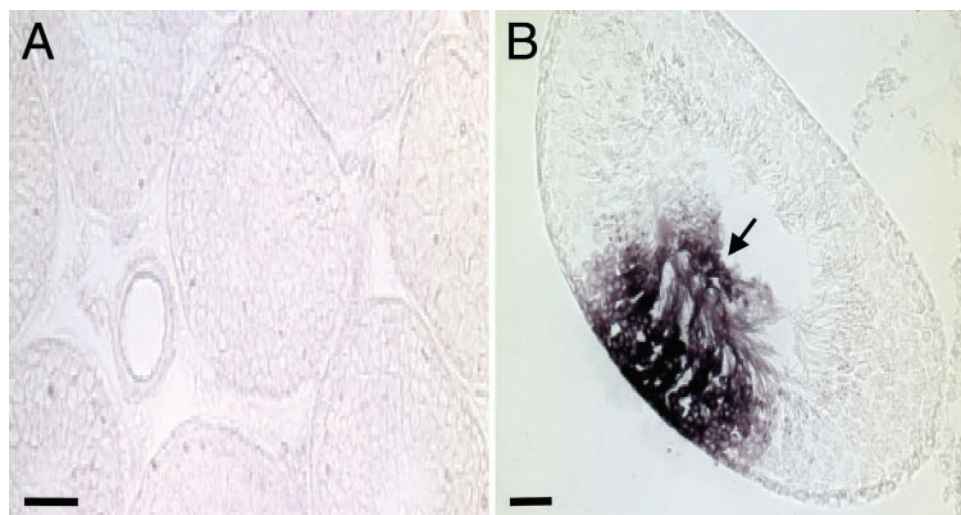

agents. Use of SuperFect greatly simplified the transfection protocol and significantly reduced the amount of plasmid DNA required for the procedure. The viral concentration protocol that we developed consistently increased the titers of the viruses by ~1,000-fold (~1 × 10<sup>10</sup> TU/ml). Furthermore, all vectors that we produced using these methods exhibited high transduction efficiencies in vivo.

Three different in vivo paradigms were used to examine the transduction efficiency of the viral particles produced using this protocol. In the first paradigm, we delivered lentiviral vector into the neural tube of the developing chicken embryo. The injected virus transduced several populations of neural progenitor cells, including those fated to become the neural retina (Fig. 4). A majority of cells exposed to virus during this stage of development are mitotic and have not yet differentiated (18). By varying the concentration of the virus injected, we found that the percent of retina transduced could be controlled in a linear fashion using doses between 10<sup>8</sup> and 10<sup>9</sup> TU/ml. Injections of virus at a concentration of 10<sup>10</sup> TU/ml produced maximal levels of retinal transduction. In a previous study, we showed that it is possible to specifically target lentiviral vector-mediated expression of transgenes to retinal photoreceptor cells by selecting appropriate promoter fragments (4). Together, these results illustrate the effectiveness of our vector to transduce cells within the developing nervous system and illustrate the potential use of this vector as a tool for studies of mechanisms regulating gene expression in vivo.

In the second paradigm, lentiviral vector carrying an EF1 $\alpha$ -eGFP transgene was injected into specific nuclei within adult rat brain. Analyses of the brains of these animals revealed that we were able to effectively target the virus to cells, including neurons, within the PVN and NTS (Fig. 5). Furthermore, the expression of GFP was robust and persisted for at least 30 days postinjection. Our ability to transduce neurons in brain nuclei involved in cardiovascular homeostasis will allow us to study both the acute and chronic physiological impact of the expression of relevant genes without generating transgenic and/or knockout animals.

Finally, we show that lentiviral vector delivered systemically can transduce several different tissues (Fig. 6) and that the transgenes carried by these vectors exhibit long-term expression (120 days, duration of the experiment). Expression of the PLAP reporter gene was highest in the liver and cardiomyocytes. Other organs, such as lung, kidney, and adrenal glands were also transduced by the vector but exhibited only limited PLAP expression. Surprisingly, our studies also showed that the systemically delivered lentiviral vector transduced germ cells in the male rat (Fig. 7). To our knowledge, this is the first example of viral vector-mediated germ cell transduction in which transgene expression was detected using histochemical methods rather than PCR-based detection methods (1, 17). Expression of PLAP was seen within the testicular tubule spermatogonia and included PLAP-positive spermatocyte, spermatid, and mature spermatozoa.

Our observation of transduced germ cells in male rats, while intriguing, must be interpreted with caution with regard to its potential impact on the use of lentiviral vectors for gene therapy. We believe that the transduction we observed could be attributed to the poorly developed blood-testicular barrier that is present in 5-day-old rats (19). It is our hypothesis that injections of lentivirus after this barrier has matured will not result in transduction of germ cells. It would be interesting to determine whether our hypothesis is correct by conducting these experiments in adult animals, an experiment that is now possible using our new viral packaging protocol.

In summary, the transfection and concentration protocols outlined here allow efficient, reproducible production of high-titer lentiviral vectors that exhibit robust transduction properties in vivo. The transfection protocol itself is simple and can be easily implemented by investigators interested in producing lentiviral vector in their laboratories. Furthermore, the methods can be easily adapted to large-scale lentiviral production protocols that are currently being developed for use in large animal studies or for possible use in clinical studies.

We thank Dr. Lung-Ji Chang (University of Florida, Gainesville, FL) for kindly providing the pNHP, pTY, and pHEF.VSVG plasmid vectors and Dr. Wolfgang Baehr (University of Utah Moran Eye Center, Salt Lake City, UT) for assistance with DNA sequencing.

The work in the United States was supported by National Institutes of Health Grants HL-33610, HL-56921, EY-11388, Training Grant EY-07132, and Core Grant EY-08571. In the United Kingdom, J. F. R. Paton is supported by the British Heart Foundation Grant BS/93003. The financial support of the Biotechnology and Biological Sciences Research Council and Royal Society is acknowledged.

## REFERENCES

1. **Arruda VR, Fields PA, Milner R, Wainwright L, De Miguel MP, Donovan PJ, Herzog RW, Nichols TC, Biegel JA, Razavi M, Dake M, Huff D, Flake AW, Couto L, Kay MA, and High KA.** Lack of germline transmission of vector sequences following systemic administration of recombinant AAV-2 vector in males. *Mol Ther* 4: 586–592, 2001.
2. **Chang LJ, Urlacher V, Iwakuma T, Cui Y, and Zucali J.** Efficacy and safety analyses of a recombinant human immunodeficiency virus type 1 derived vector system. *Gene Ther* 6: 715–728, 1999.
3. **Chen CM, Smith DM, Peters MA, Samson ME, Zitz J, Tabin CJ, and Cepko CL.** Production and design of more effective avian replication-incompetent retroviral vectors. *Dev Biol* 214: 370–384, 1999.
4. **Coleman JE, Fuchs GE, and Semple-Rowland SL.** Analyses of the guanylate cyclase activating protein-1 gene promoter in the developing retina. *Invest Ophthalmol Vis Sci* 43: 1335–1343, 2002.
5. **Cui Y, Iwakuma T, and Chang LJ.** Contributions of viral splice sites and cis-regulatory elements to lentivirus vector function. *J Virol* 73: 6171–6176, 1999.
6. **Farson D, Witt R, McGuinness R, Dull T, Kelly M, Song J, Radeke R, Bukovsky A, Consiglio A, and Naldini L.** A new-generation stable inducible packaging cell line for lentiviral vectors. *Hum Gene Ther* 12: 981–997, 2001.
7. **Fekete DM and Cepko CL.** Replication-competent retroviral vectors encoding alkaline phosphatase reveal spatial restriction of viral gene expression/transduction in the chick embryo. *Mol Cell Biol* 13: 2604–2613, 1993.
8. **Follenzi A, Ailles LE, Bakovic S, Geuna M, and Naldini L.** Gene transfer by lentiviral vectors is limited by nuclear translo-

- cation and rescued by HIV-1 pol sequences. *Nat Genet* 25: 217–222, 2000.
9. **Huentelman MJ, Reaves PY, Katovich MJ, and Raizada MK.** Large-scale production of retroviral vectors for systemic gene delivery. *Methods Enzymol* 346: 562–573, 2002.
  10. **Iwakuma T, Cui Y, and Chang LJ.** Self-inactivating lentiviral vectors with U3 and U5 modifications. *Virology* 261: 120–132, 1999.
  11. **Jorgensen NP, Nossen JO, Borch KW, Kristiansen AB, Kristoffersen DT, Lundby B, and Theodorsen L.** Safety and tolerability of iodixanol in healthy volunteers with reference to two monomeric X-ray contrast media. *Eur J Radiol* 15: 252–257, 1992.
  12. **Klages N, Zufferey R, and Trono D.** A stable system for the high-titer production of multiply attenuated lentiviral vectors. *Mol Ther* 2: 170–176, 2000.
  13. **Kumar M, Keller B, Makalou N, and Sutton RE.** Systematic determination of the packaging limit of lentiviral vectors. *Hum Gene Ther* 12: 1893–1905, 2001.
  14. **Miyoshi H, Blomer U, Takahashi M, Gage FH, and Verma IM.** Development of a self-inactivating lentivirus vector. *J Virol* 72: 8150–8157, 1998.
  15. **Naldini L, Blomer U, Gallay P, Ory D, Mulligan R, Gage FH, Verma IM, and Trono D.** In vivo gene delivery and stable transduction of nondividing cells by a lentiviral vector. *Science* 272: 263–267, 1996.
  16. **Pacchia AL, Adelson ME, Kaul M, Ron Y, and Dougherty JP.** An inducible packaging cell system for safe, efficient lentiviral vector production in the absence of HIV-1 accessory proteins. *Virology* 282: 77–86, 2001.
  17. **Peters AH, Drumm J, Ferrell C, Roth DA, Roth DM, McCaman M, Novak PL, Friedman J, Engler R, and Braun RE.** Absence of germline infection in male mice following intraventricular injection of adenovirus. *Mol Ther* 4: 603–613, 2001.
  18. **Prada C, Puga J, Perez-Mendez L, Lopez R, and Ramirez G.** Spatial and temporal patterns of neurogenesis in the chick retina. *Eur J Neurosci* 3: 559–569, 1991.
  19. **Toyama Y, Ohkawa M, Oku R, Maekawa M, and Yuasa S.** Neonatally administered diethylstilbestrol retards the development of the blood-testis barrier in the rat. *J Androl* 22: 413–423, 2001.
  20. **Xu K, Ma H, McCown TJ, Verma IM, and Kafri T.** Generation of a stable cell line producing high-titer self-inactivating lentiviral vectors. *Mol Ther* 3: 97–104, 2001.
  21. **Zaiss AK, Son S, and Chang LJ.** RNA 3' read through of oncoretrovirus and lentivirus: Implications for vector safety and efficacy. *J Virol* 76: 2002.
  22. **Zennou V, Petit C, Guetard D, Nerhbass U, Montagnier L, and Charneau P.** HIV-1 genome nuclear import is mediated by a central DNA flap. *Cell* 101: 173–185, 2000.
  23. **Zennou V, Serguera C, Sarkis C, Colin P, Perret E, Mallet J, and Charneau P.** The HIV-1 DNA flap stimulates HIV vector-mediated cell transduction in the brain. *Nat Biotechnol* 19: 446–450, 2001.
  24. **Zufferey R, Dull T, Mandel RJ, Bukovsky A, Quiroz D, Naldini L, and Trono D.** Self-inactivating lentivirus vector for safe and efficient in vivo gene delivery. *J Virol* 72: 9873–9880, 1998.

